

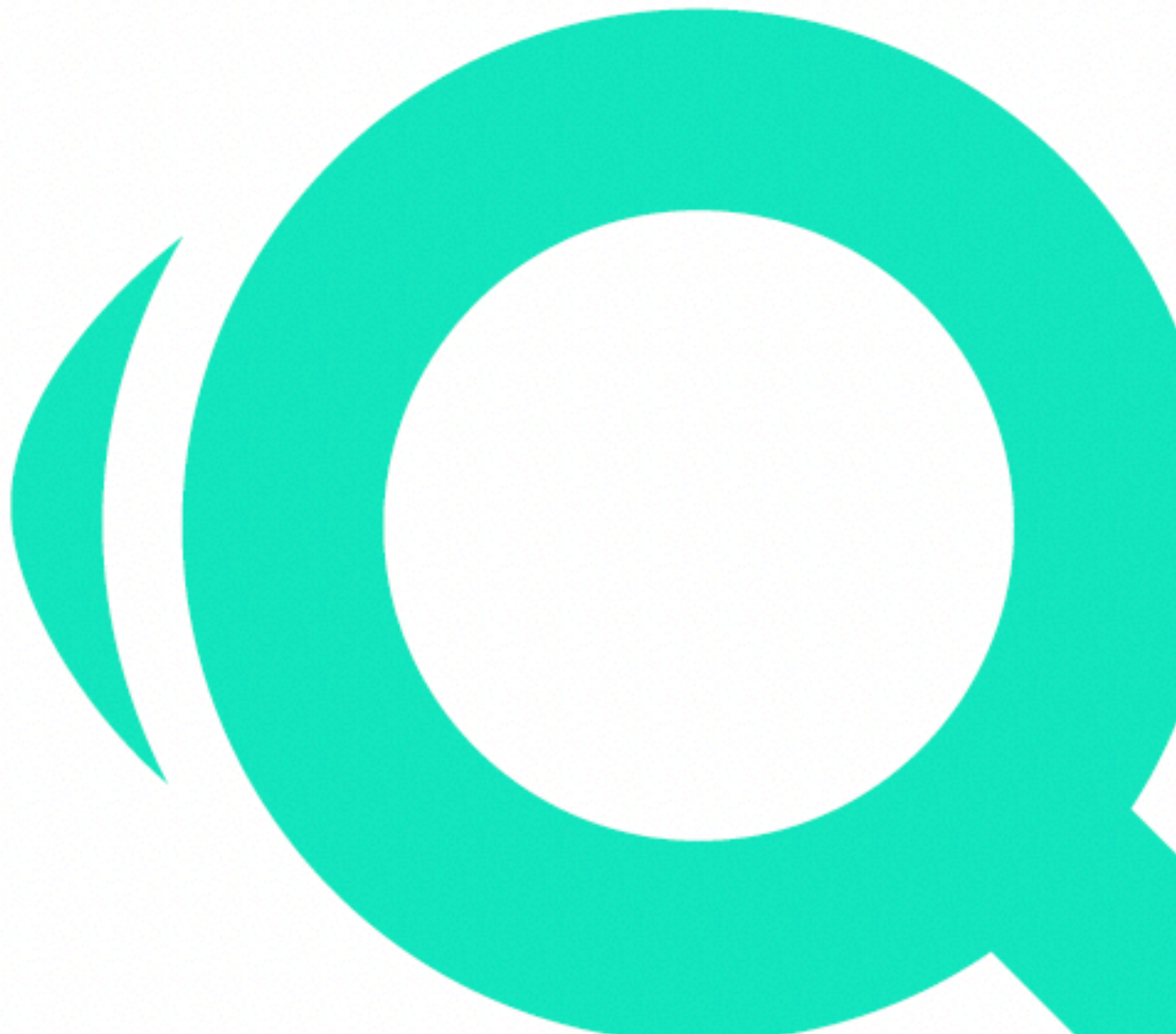

#seriousfun

# Quickstart Guide



## Ready for the SPORT QUANTUM experience?



## Before using your target, please read all the enclosed instructions.

Thank you for buying the SPORT QUANTUM **SQ Air 10**. The guide below is full of tips for getting your product up and running for the first time.

However, if you are unable to configure your target on your own, you can contact customer support by e-mail:

[support@sportquantum.com](mailto:support@sportquantum.com) or on **+33 980 087 087**

Please have your target ready. You can also download the user manual and general conditions of use here:

Customer:

Model:

Serial no:

Date of installation:



# Unpacking the Interactive target SQ Air 10



## Quality testing

Your target is delivered with a protective impact plate, which includes shot impacts (proof of quality process: each target is tested in real-life conditions).

## Target handling

As shown in the photo below, the target has two easy-to-reach handles for removing it from its original packaging.

## Carton folding

Please keep the original carton for the duration of the warranty period.

**Important:** in the event of a return to After Sales Services, this packaging is essential. Do not use any other packaging.



# Getting started with Interactive target SQ Air 10

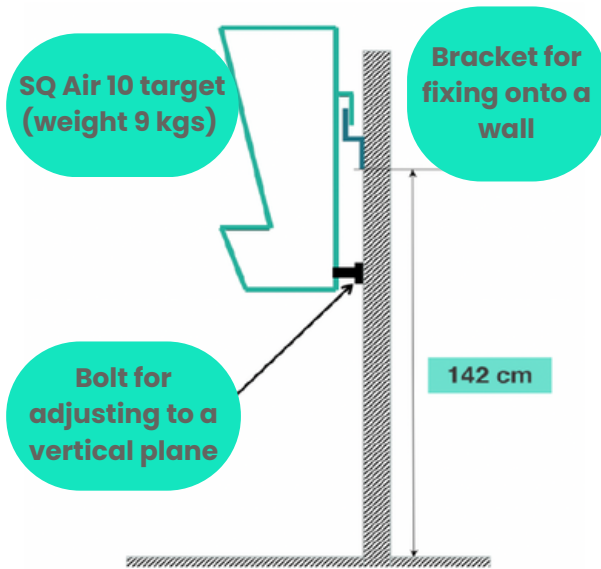

## Installation conditions and recommendations

The target must be securely fixed:

- Wall-mounted using the supplied bracket (see attached diagram)
- On an optional tripod supplied by SPORT QUANTUM

For all other mounting options, please refer to the accessory instructions

- The metal back of the target must be 10.18m from your firing line
- The center of the precision pistol sight must be 1.40m from the ground

## Precautions for use

- Using a clean cloth, apply a little silicone gel to the polycarbonate impact plate that protects the SQ Air 10's screen from the very first use (a tube is supplied with your target order)
- Repeat this action regularly to create a light protective film, concentrating on the center of the target
- Between 2 maintenance sessions with silicone gel clean your target with rubbing alcohol and a soft cloth
- It's normal for the rifle target sight not always to be completely centered. It moves very slightly to limit wear on the impact plate
- Position the power supply unit in an area protected from direct fire
- Once your target has been switched off, to switch it back on, simply shoot at it or unplug it and then, after 5 to 10 seconds, plug it back in
- Do not shoot at the target without the cover or the pellet drawer

## Setting up the target

- Fix the bracket to the wall using the supplied wall plugs (for concrete walls)
  - Hang the target on the bracket using the two hooks on the back of the target
  - Adjust the inclination of the target using the verticality bolts
- Use a spirit level to check verticality
- Take the SQ Touch tablet out of its box and place it on the shooting table in front of its target



# Getting started with Interactive target SQ Air 10



## Setting up a target - Point-to-point target

- Connect target and tablet to their respective power supplies
- By default, the target is delivered wired, so connect it to the tablet using the RJ45 cable (see photo on left)
- The target is ready for use. The application launches and connects about 1 minute after power-up. If you have requested WiFi mode configuration, please refer to the “WiFi” chapter of the user manual:



## Multi-target start up

- USB sticks are supplied with all targets, enabling stand configuration (USB key n°1 with target n°1 and tablet n°1 and so on...)
- After removing the top cover of the electronics compartment, insert the USB key of the corresponding target into its USB port (see photo)
- Connect RJ45 cables to targets, POE switches and SQ tablets (refer to the wiring diagram supplied)
- Connect the power cables of the various devices
- Targets are ready to use. The application launches and connects about 1 minute after power-up
- If your targets are in WiFi mode, please refer to the user manual

# Interactive target SQ Air 10

## Start-up sheet



### TO TURN ON THE SQ AIR 10

- When the stand is switched on, wait for the target to light up and the Sport Quantum logo to appear on the target display
- If your target is in standby mode, firing at it will reactivate it

### SWITCH ON SQ TOUCH

- Press the bottom right button on the back of the SQ Touch, and the application will launch automatically

### DIFFERENT MODES

Choose your shooting preference (pistol or rifle) and select your module:

#### • Training Tools

- For exercises in coordination, aiming, trigger release, stability, hold repeatability, etc

For more information, click on the 

- Select your discipline or exercise on the left, then preview the target display on the right of the screen
- Click on the  and your session will start

#### • Precision shooting

- To start a match, select the discipline ISSF: "standards" etc.
- For precision training, choose precision exercises
- Click on the  and your session will start

#### • Fun learning

- Choose a game or exercise, then the game starts and the timer runs
- Some games are demos, and therefore limited to a certain number of impacts
- Some games allow two players

#### • Themed Training Sessions

The virtual coach guides the shooter through a series of exercises built around a specific theme: target entry, release zone, etc. Complete training sessions (60 minutes) covering multiple technical aspects.

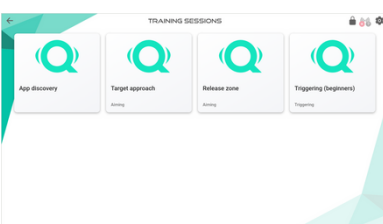
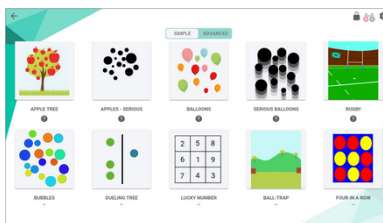
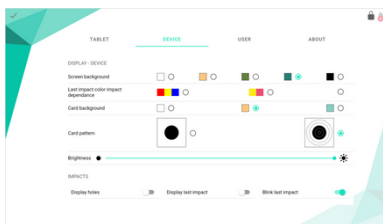
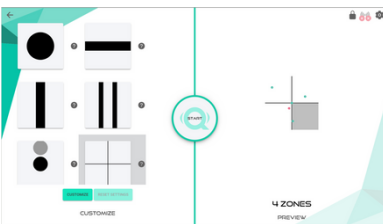

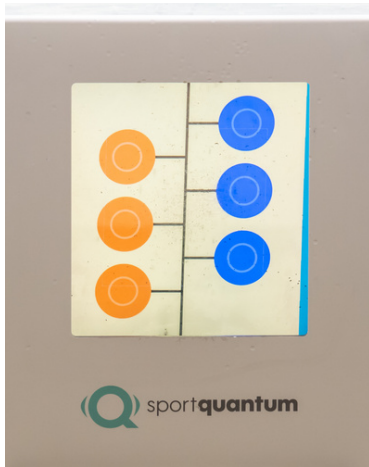

### USER SETTINGS

You can set various display parameters and also export your data.

Your scores are displayed on the SQ Touch screen, along with your training or competition time.

### ADJUST YOUR SETTINGS

- You can set the exercise level, language, background colour, user profile, difficulty level, brightness...
- Close this window by pressing the ✓ icon in the top left-hand corner

### WHEN YOU'RE FINISHED

- In the main menu, click on the "turn off target" button. You can reactivate the target simply by shooting onto the screen
- To switch off the tablet, press the bottom right button on the back of the SQ Touch



To be downloaded and placed on the shooting tables for each user

# The SPORT QUANTUM team is at your service your service

## After Sales Service

### e-mail:

[support@sportquantum.com](mailto:support@sportquantum.com)

### Telephone:

+33 980 087 087

**Please** contact the distributor who supplied your SQ Air 10 target

## Sport Quantum

4 Rue René Razel  
91400 Saclay  
FRANCE

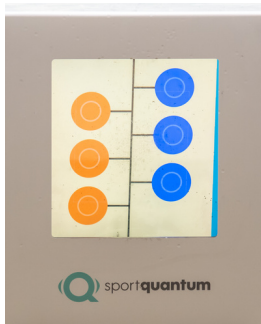
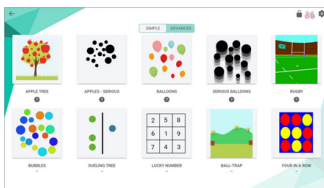
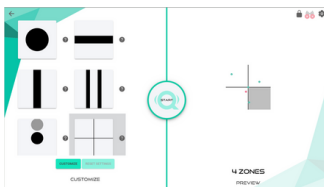

### POWER ON THE SQ AIR 10

- When the target is powered on, wait for the target to light up and the color SPORT QUANTUM logo to appear on the target display
- If the target is in standby, you can either shoot at the target from afar, or disconnect and reconnect power supply after 10 seconds

### POWER ON SQ TOUCH TABLET

- Press the button on the right hand side at the bottom back of the tablet, the application will start automatically at boot-up

### DIFFERENT ACTIVITES

Choose your shooting mode (pistol or rifle) and select the activity:

#### • Training Tools

- For practice tools in coordination, aiming, trigger release, stability, hold repeatability, etc

For more information, click on the (?)

- Select the discipline or exercise on the left, then preview the target display on the right of the screen

- Click on the  to start the session

#### • Precision shooting

- To start a match, select the discipline from national or ISSF disciplines

- To start a precision shooting training, choose "free shooting"

- Click on the  to start the session

#### • Fun learning

- Choose a game or exercise

- Some demos aren't limited to a certain number of impacts

- Some games can be played with two or more players

### USER SETTINGS

You can set various display settings and also export your data. Your scores are displayed on the SQ Touch tablet, along with the training, sighting or match duration

### TABLET PARAMETERS

- You can set the language, background color, user profile, brightness...
- Close this window by pressing the ✓ icon in the top left-hand corner

### WHEN YOU'RE FINISHED

- In the main menu, click on the "turn off target" button
- If the target is in standby, you can either shoot at the target from afar, or disconnect and reconnect power supply after 10 seconds
- To put the SQ Touch tablet in standby, press the button on the right hand side at the bottom back of the tablet. To power down, long press 3 seconds and click "shutdown" on the screen

